

Handyman

SPRINGS

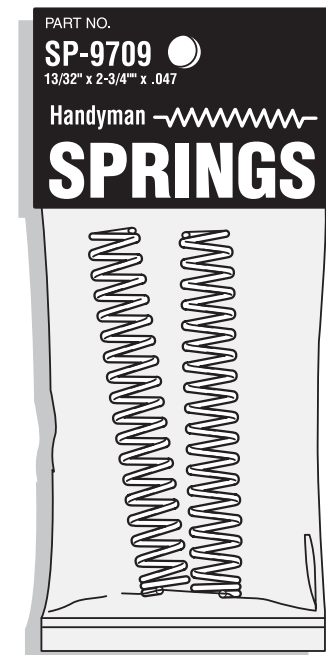
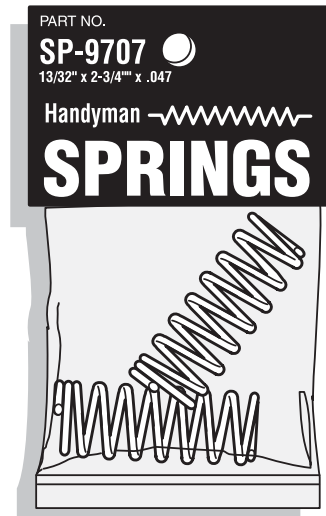
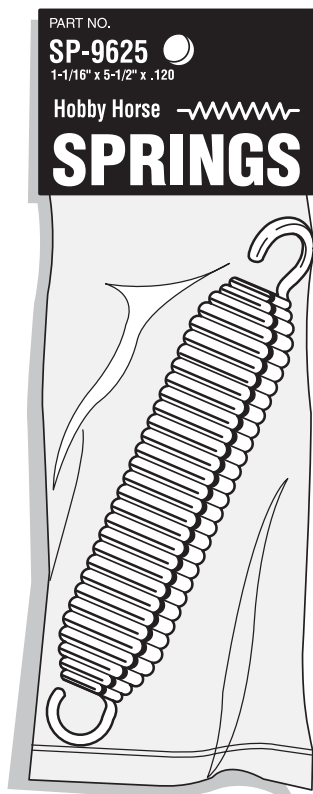

- **All springs are bagged and headered.**
- The header was specially designed for durability and distinctive presentation.
- **The bag is 4 mil and protects springs from dust and dirt.**

Handyman Springs

Extension Springs

Part No.	Outside Diameter	Length	Wire	Qty. Per Bag	Max. Safe Load (lbs.)	Max. Deflection (in.)
SP 9600	1/4"	1-1/2"	.035	2	8.46	1.11
SP 9601	5/16"	1-1/2"	.020	2	1.39	7.62
SP 9602	7/16"	1-1/2"	.047	2	11.50	1.71
SP 9603	1/4"	1-7/8"	.035	2	8.46	1.47
SP 9604	11/32"	1-7/8"	.025	2	2.40	7.26
SP 9605	7/16"	1-7/8"	.047	2	11.50	2.40
SP 9606	5/32"	2-1/2"	.020	2	2.69	2.92
SP 9607	1/4"	2-1/2"	.016	2	.90	15.50
SP 9608	7/16"	2-1/2"	.047	2	11.50	3.51
SP 9609	7/16"	2"	.062	2	18.00	.76
SP 9610	5/8"	2-1/2"	.072	2	19.10	.92
SP 9611	9/16"	3"	.054	2	9.55	3.64
SP 9612	7/16"	2-3/4"	.034	2	3.57	6.08
SP 9613	1/2"	1-5/8"	.080	2	31.30	.36
SP 9614	3/4"	2"	.105	2	46.20	.51
SP 9615	3/4"	2-1/4"	.105	2	46.20	.64
SP 9616	3/4"	2-7/16"	.105	2	46.20	.74
SP 9617	3/4"	2-5/8"	.105	2	46.20	.82
SP 9618	5/8"	3-1/4"	.072	2	19.10	2.01
SP 9619	3/4"	2-7/8"	.105	2	46.20	.95
SP 9620	3/4"	3-1/8"	.105	2	46.20	1.08
SP 9621	15/32"	4-1/2"	.041	2	5.28	8.33
SP 9622	5/8"	6-1/2"	.054	2	8.64	11.90
SP 9623	13/16"	3-1/8"	Trampoline	2	61.70	.77
SP 9624	13/16"	4"	.120	2	61.70	.73
SP 9625	1-1/16"	5-1/2"	Hobby Horse	1	48.20	3.62
SP 9626	15/16"	8"	Gate Spring	1	—	—
SP 9627	7/8"	6"	.091	1	32.50	5.60
SP 9628	1-1/16"	7"	.105	1	33.40	7.19
SP 9629	1-1/4"	6-1/2"	.162	1	93.70	3.00
SP 9630	1"	7"	.135	1	69.90	2.93
SP 9631	3/4"	6-1/2"	.091	1	31.30	4.20
SP 9632	1/2"	8-1/2"	.047	1	7.47	13.30
SP 9633	7/16"	8-1/2"	.047	1	8.47	9.30
SP 9634	9/16"	8-1/2"	.054	1	9.55	12.40
SP 9635	5/8"	8-1/2"	.080	1	25.60	5.20
SP 9636	1"	8-1/2"	.120	1	51.00	5.38
SP 9637	1"	12"	.105	1	35.40	11.70
SP 9638	7/16"	10-1/4"	.041	1	5.60	17.50
SP 9639	9/16"	16-1/2"	.054	1	9.50	25.20
SP 9645	1-1/8"	16"	.105	1	31.20	22.00

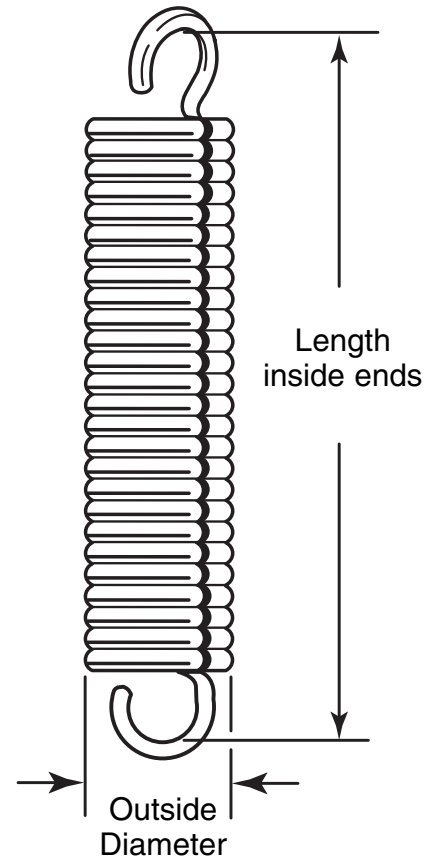

Compression Springs

Part No.	Outside Diameter	Length	Wire	Qty. Per Bag	Max. Safe Load (lbs.)	Solid Height
SP 9700	1/4"	1/2"	.035	6	11.40	.262
SP 9701	1/4"	1"	.035	6	11.40	.524
SP 9702	3/8"	3/4"	.032	6	4.47	.230
SP 9703	3/8"	1-1/8"	.041	4	9.00	.461
SP 9704	7/32"	1-3/4"	.020	4	2.60	.375
SP 9705	7/16"	2-1/8"	.031	4	3.85	.402
SP 9706	1/2"	1-1/2"	.041	2	6.84	.400
SP 9707	9/16"	1-3/8"	.072	2	28.20	.738
SP 9708	11/16"	1-1/4"	.091	2	44.70	.755
SP 9709	13/32"	2-3/4"	.047	2	12.40	1.128
SP 9710	1/2"	2-3/4"	.072	2	31.30	1.560
SP 9711	23/32"	3-1/2"	.041	2	4.82	.461
SP 9712	9/16"	3"	.054	2	12.90	.954
SP 9713	7/8"	4"	.080	2	24.80	1.280

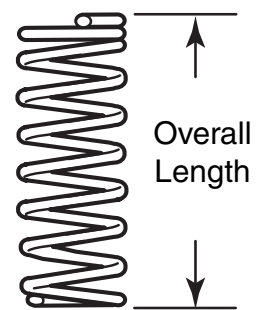

Description: Nickel plated spring steel; used for a variety of household applications.

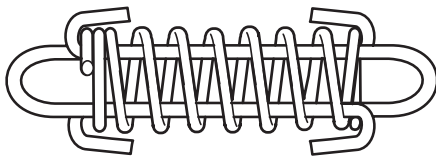
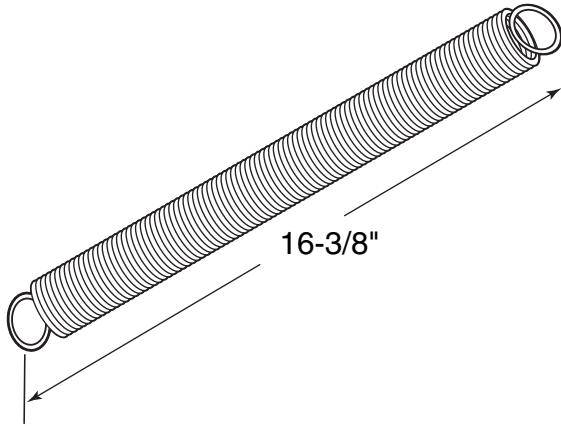

Wood Screen Door Springs (Bulk)

Part No.	Finish	Outside Diameter	Wire	Qty. Per Box	Max. Safe Load (lbs.)
SP 9640	Zinc	5/16"	.050	10	13.80
SP 9641	Zinc	23/64"	.059	10	15.70
SP 9642	Zinc	13/32"	.060	10	19.60
SP 9643	Zinc	15/32"	.065	10	23.10
SP 9644	Zinc	1/2"	.075	10	26.40
SP 9650	Black	5/16"	.050	10	13.80
SP 9651	Black	23/64"	.059	10	15.70
SP 9652	Black	13/32"	.060	10	19.60
SP 9653	Black	15/32"	.065	10	23.10

Porch Spring

Part No.	Outside Diameter	Wire	Qty. Per Bag	Max. Safe Load (lbs.)
SP 9649	1-9/16"	.227	1	352

Planogramming Suggestions

- Both planograms depict the best 54 sku assortment
- Part no. and overall length of bag is noted for each item

