

PH-17015
PH-17016

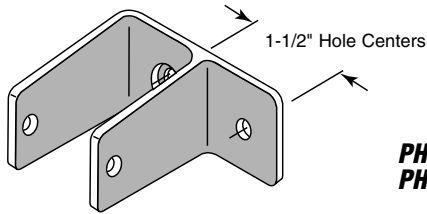

PH-17017
PH-17018

PH-17019
PH-17020

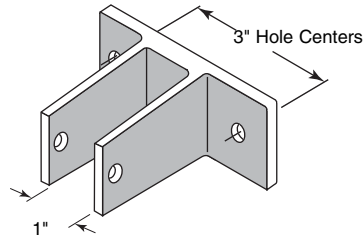
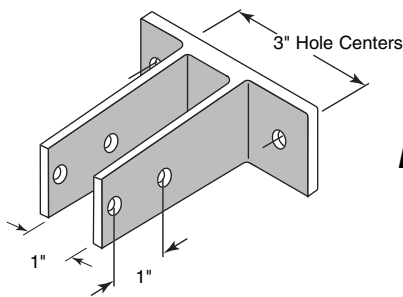
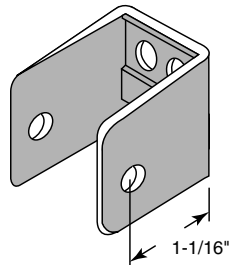

PH-17021

PH-17022

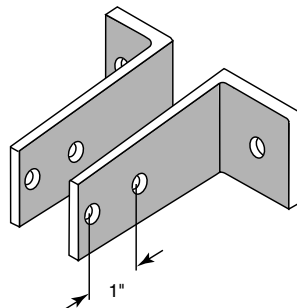

PH-17015 (For 1" panels)
PH-17016 (For 1-1/4" panels)

Two-Ear Wall Bracket

Contents: 1 bracket.

Description: Chrome plated, diecast bracket for attaching partition panel to wall.

You may wish to stock these related parts: **PH-17009**, **PH-17039**, **PH-17061**, **PH-17064**.

PH-17017 (For 1" panels)
PH-17018 (For 1-1/4" panels)

One-Ear Wall Bracket

Contents: 1 bracket.

Description: Chrome plated, diecast bracket for attaching partition panel to wall.

You may wish to stock these related parts: **PH-17008**, **PH-17038**, **PH-17061**, **PH-17063**.

PH-17019 (For 1" panels)
PH-17020 (For 1-1/4" panels)

"U" Bracket

Contents: 1 bracket.

Description: Chrome plated, diecast bracket for attaching partition panel to wall.

You may wish to stock these related parts: **PH-17015**, **PH-17040**, **PH-17059**, **PH-17061**.

PH-17021 (For 1" panels)

Urinal Screen Wall Bracket

Contents: 1 bracket.

Description: Chrome plated, diecast bracket for attaching urinal screen partition panels to wall.

You may wish to stock these related parts: **PH-17015**, **PH-17040**, **PH-17059**, **PH-17061**.

PH-17022 (All size panels)

Urinal Screen Wall Bracket

Contents: 1 bracket.

Description: Chrome plated, diecast bracket for attaching urinal screen partition panels to wall.

You may wish to stock these related parts: **PH-17015**, **PH-17040**, **PH-17059**, **PH-17061**.

Restroom Partition Hardware

PH-17023 (For 1" panels)

Headrail Bracket

Contents: 1 headrail bracket.

Description: Chrome plated, diecast bracket for attaching headrail support to wall.

You may wish to stock these related parts: **PH-17016, PH-17029, PH-17057, PH-17061.**

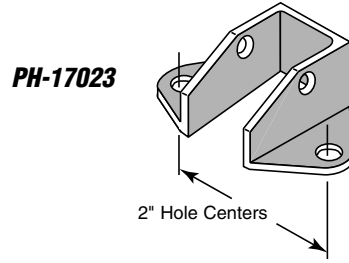

PH-17024

Bottom Hinge Bracket

Contents: 1 hinge bracket.

Description: Chrome plated, diecast bottom hinge bracket for bottom of door; use with steel panels; fits 1-1/4" pilaster.

You may wish to stock these related parts: **PH-17013, PH-17044, PH-17057, PH-17061.**

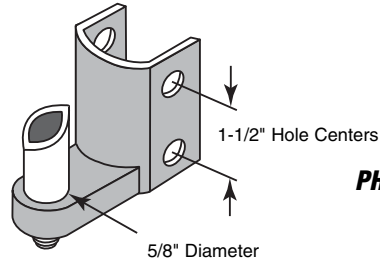

PH-17025

Top Hinge Bracket

Contents: 1 hinge bracket.

Description: Chrome plated, diecast top hinge bracket for top of door; use with steel panels; fits 1-1/4" pilaster.

You may wish to stock these related parts: **PH-17014, PH-17037, PH-17055, PH-17061.**

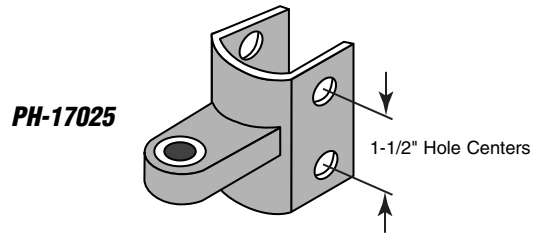

PH-17026

Bottom Hinge Bracket

Contents: 1 hinge bracket.

Description: Chrome plated, diecast bottom hinge bracket for bottom of door; use with plastic laminate or marble panels; fits 1-1/4" pilaster.

You may wish to stock these related parts: **PH-17017, PH-17031, PH-17055, PH-17061.**

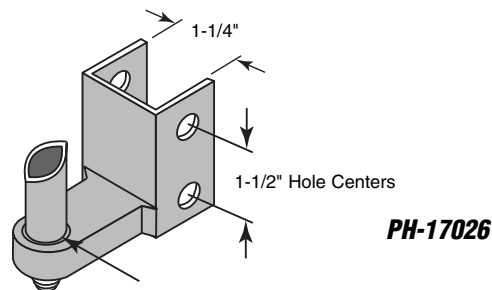

PH-17027

Top Hinge Bracket

Contents: 1 hinge bracket.

Description: Chrome plated, diecast top hinge bracket for top of door; use with plastic laminate or marble panels; fits 1-1/4" pilaster.

You may wish to stock these related parts: **PH-17015, PH-17040, PH-17059, PH-17061.**

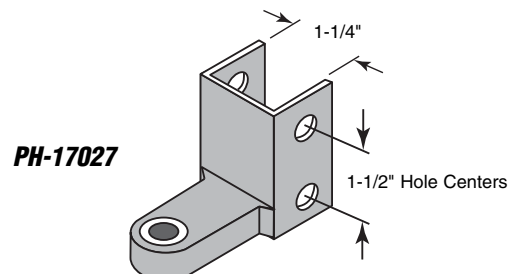

PH-17008

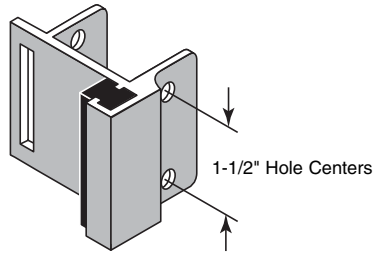

PH-17008 (For 1-1/4" pilaster)

Strike/Keeper

Contents: 1 strike/keeper.

Description: Chrome plated, diecast keeper; surface slide latch for supporting and latching of **inswing** doors; use with plastic laminate or marble panels.

You may wish to stock these related parts: **PH-17010, PH-17039, PH-17061, PH-17064.**

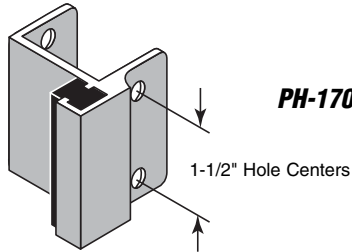

PH-17009

PH-17009 (For 1-1/4" pilaster)

Strike/Keeper

Contents: 1 strike/keeper.

Description: Chrome plated, diecast keeper; surface slide latch for supporting and latching of **outswing** doors; use with plastic laminate or marble panels.

You may wish to stock these related parts: **PH-17016, PH-17042, PH-17057, PH-17061.**

PH-17028

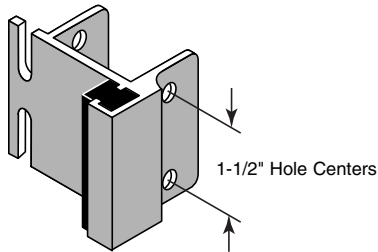

PH-17028 (For 1-1/4" pilaster)

Strike/Keeper

Contents: 1 strike/keeper.

Description: Chrome plated, diecast keeper; use with plastic laminate or marble panels; for throw latch on **outswing** door.

You may wish to stock these related parts: **PH-17016, PH-17042, PH-17057, PH-17061.**

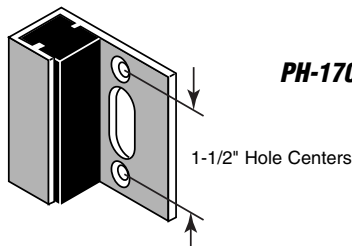

PH-17029

PH-17029

Flat Strike

Contents: 1 flat strike.

Description: Chrome plated, diecast keeper; use with plastic laminate or marble panels; fits any size pilaster; for concealed latch on **inswing** door.

You may wish to stock these related parts: **PH-17014, PH-17037, PH-17055, PH-17061.**

PH-17030

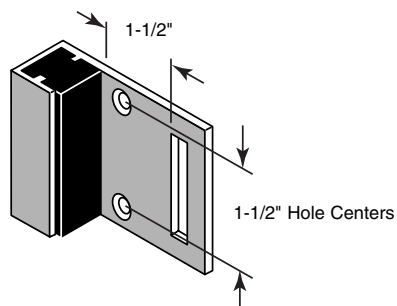

PH-17030

Flat Strike

Contents: 1 flat strike.

Description: Chrome plated, diecast keeper; use with plastic laminate or marble panels; fits any size pilaster; for slide latch on **inswing** door.

You may wish to stock these related parts: **PH-17017, PH-17031, PH-17055, PH-17061.**

Restroom Partition Hardware

PH-17031

Flat Strike

Contents: 1 flat strike.

Description: Chrome plated, diecast strike; use with plastic laminate or marble panels; fits any size pilaster; for slide latch on outswing door.

You may wish to stock these related parts: PH-17015, PH-17040, PH-17059, PH-17061.

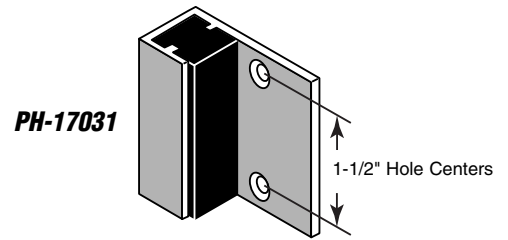

PH-17032

Keeper

Contents: 1 keeper.

Description: Chrome plated, diecast keeper for slide latch; fits any size pilaster.

You may wish to stock these related parts: PH-17014, PH-17037, PH-17055, PH-17061.

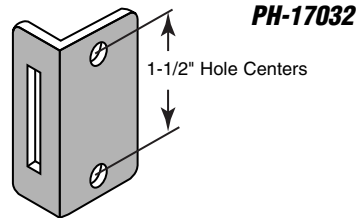

PH-17033

Strike

Contents: 1 strike.

Description: Chrome plated, diecast strike for slide latch or throw latch; fits any size pilaster.

You may wish to stock these related parts: PH-17009, PH-17036, PH-17048, PH-17061.

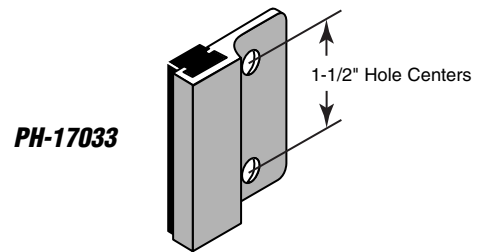

PH-17034

Keeper

Contents: 1 keeper.

Description: Chrome plated, diecast keeper for throw latch; fits any size pilaster.

You may wish to stock these related parts: PH-17044, PH-17046, PH-17061, PH-17063.

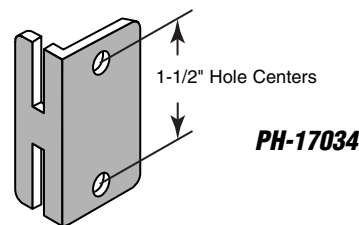

PH-17035 (For 1-1/4" pilaster)

Strike/Keeper

Contents: 1 strike/keeper.

Description: Chrome plated, diecast keeper; use with steel panels; for slide latch on inswing door.

You may wish to stock these related parts: PH-17039, PH-17040, PH-17048, PH-17061.

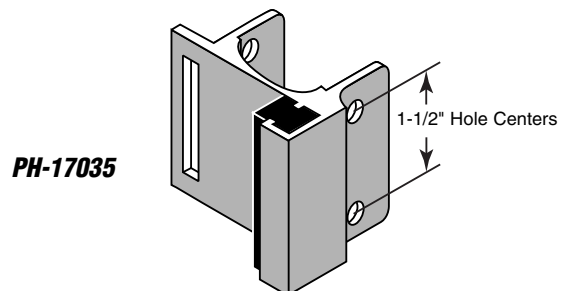

PH-17036

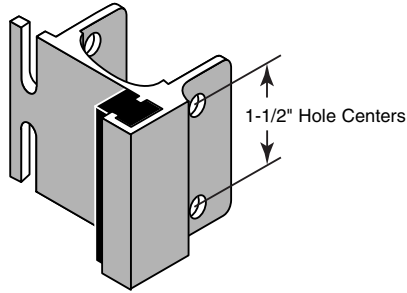

PH-17036 (For 1-1/4" pilaster)

Strike/Keeper

Contents: 1 strike/keeper.

Description: Chrome plated, diecast strike/keeper; use with steel panels; for throw latch on **inswing** door.

You may wish to stock these related parts: **PH-17044**, **PH-17048**, **PH-17061**, **PH-17064**.

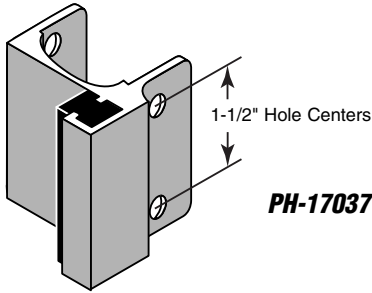

PH-17037 (For 1-1/4" pilaster)

Strike/Keeper

Contents: 1 strike/keeper.

Description: Chrome plated, diecast strike/keeper; use with steel panels; for throw latch on **outswing** door.

You may wish to stock these related parts: **PH-17039**, **PH-17040**, **PH-17046**, **PH-17061**.

PH-17038

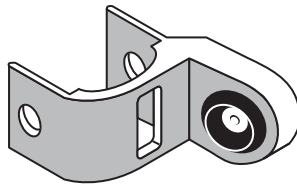

PH-17038 (For 1-1/4" pilaster)

Strike/Keeper

Contents: 1 strike/keeper.

Description: Chrome plated, diecast strike/keeper; use with steel panels; for round bar concealed latch.

You may wish to stock these related parts: **PH-17041**, **PH-17042**, **PH-17043**, **PH-17061**.

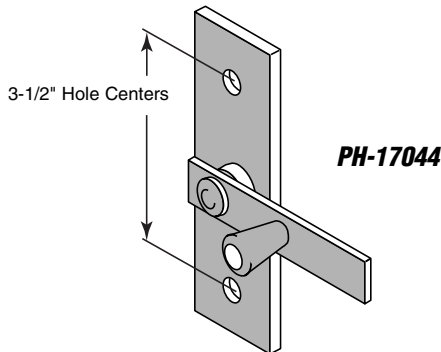

PH-17044

Throw Latch

Contents: 1 slide latch.

Description: Chrome plated, brass throw latch; use with any door thickness.

You may wish to stock these related parts: **PH-17028**, **PH-17034**, **PH-17036**, **PH-17061**.

PH-17039

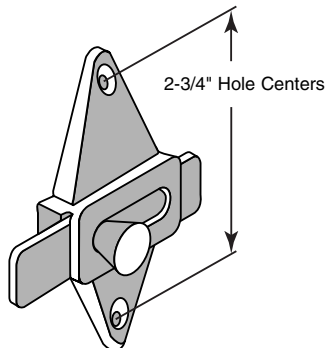

PH-17039

Slide Latch

Contents: 1 slide latch.

Description: Chrome plated, diecast slide latch; use with any door thickness.

You may wish to stock these related parts: **PH-17030**, **PH-17032**, **PH-17035**, **PH-17061**.

Restroom Partition Hardware

PH-17040

Slide Latch

Contents: 1 slide latch.

Description: Chrome plated, diecast slide latch; use with any thickness door.

You may wish to stock these related parts: PH-17030, PH-17032, PH-17035, PH-17061.

PH-17040

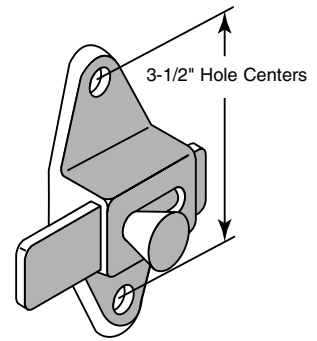

PH-17041

Emergency Entry Knob

Contents: 1 emergency entry knob.

Description: Chrome plated, diecast entry knob; use with PH-17045 concealed door lock.

You may wish to stock these related parts: PH-17042, PH-17045.

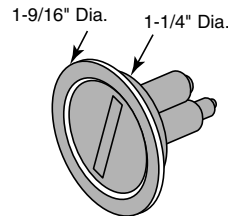

PH-17041

PH-17042

Interior Locking Knob

Contents: 1 interior locking knob.

Description: Chrome plated, diecast locking knob; use with PH-17045 concealed door lock.

You may wish to stock these related parts: PH-17042, PH-17045.

PH-17042

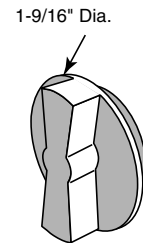

PH-17043

Concealed Lock

Contents: 1 concealed lock.

Description: Chrome plated, diecast concealed lock with straight bar; use with 1" thick laminate doors.

You may wish to stock these related parts: PH-17029, PH-17038, PH-17046, PH-17061.

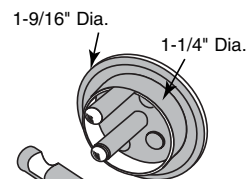

PH-17043

PH-17062

Concealed Lock

Contents: 1 concealed lock.

Description: Chrome plated, diecast concealed lock with flat bar; use with 1" thick steel doors.

You may wish to stock these related parts: PH-17039, PH-17040, PH-17043, PH-17044.

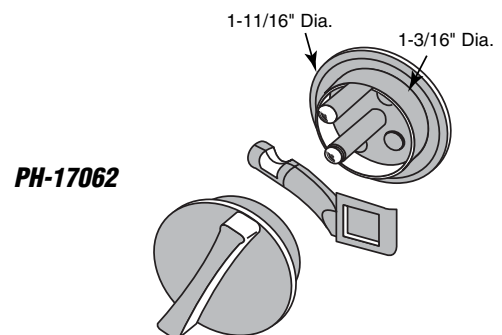

PH-17062

PH-17045

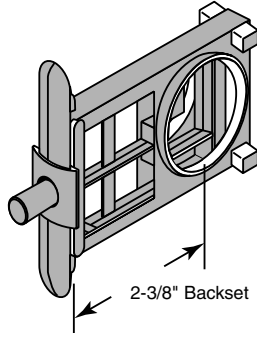

PH-17045
Concealed Door Lock

Contents: 1 concealed door lock.

Description: Zamak diecasting; for use on 1" thick doors; may be used with PH-17041 and PH-17042.

You may wish to stock these related parts: PH-17041, PH-17042.

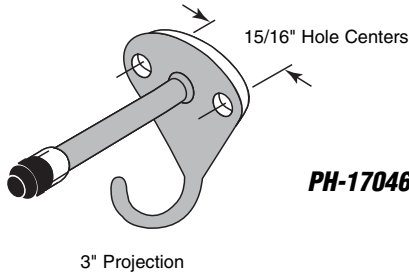

PH-17046
Bumper Hook

Contents: 1 bumper hook.

Description: Chrome plated, diecast bumper hook; rubber tipped; for general purpose use.

You may wish to stock these related parts: PH-17039, PH-17040, PH-17044, PH-17061.

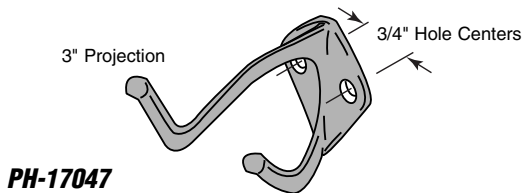

PH-17047
Coat Hook

Contents: 1 coat hook.

Description: Chrome plated, diecast coat hook; two prongs; for general purpose use.

You may wish to stock these related parts: PH-17039, PH-17040, PH-17044, PH-17061.

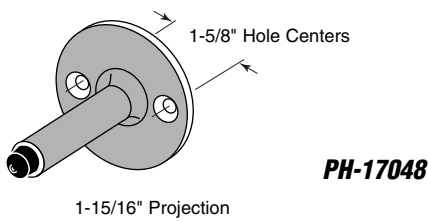

PH-17048
Door Stop

Contents: 1 door stop.

Description: Chrome plated, diecast door stop; rubber tipped; for general purpose use.

You may wish to stock these related parts: PH-17039, PH-17040, PH-17044, PH-17061.

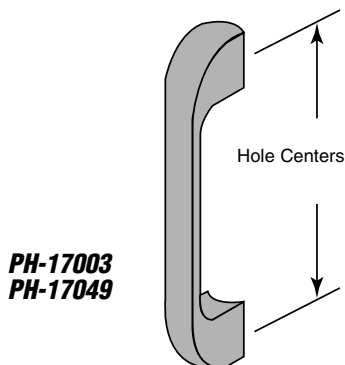

PH-17003 (3-1/2" hole centers)
PH-17049 (3-1/2" and 4" hole centers)

Door Pull

Contents: 1 door pull.

Description: Chrome plated, diecast door pull; 4-#10-24 tapped holes; for general purpose use.

You may wish to stock these related parts: PH-17039, PH-17040, PH-17044, PH-17061.

Restroom Partition Hardware

PH-17050 (1/2" Chrome plated brass)

PH-17051 (5/8" Chrome plated steel)

PH-17052 (5/8" Chrome plated brass)

"One-Way" Barrel Nut

Contents: 10 barrel nuts.

Description: Chrome plated, brass and steel barrel nuts; #10-24 threads; use with shoulder bolts for various part assemblies.

**PH-17050
PH-17051
PH-17052**

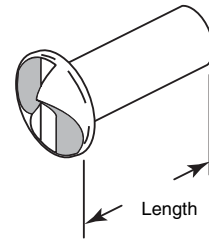

PH-17053 (1/2" Chrome plated brass)

PH-17054 (15/16" Chrome plated brass)

PH-17055 (1-3/16" Chrome plated steel)

"One-Way" Shoulder Screw

Contents: 10 shoulder screws.

Description: Chrome plated, brass and steel shoulder screws; #10-24 threads; use with barrel nuts for various part assemblies.

**PH-17053
PH-17054
PH-17055**

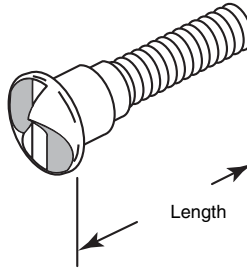

PH-17056 (3/4" Chrome plated steel)

PH-17057 (1-3/8" Chrome plated steel)

"One-Way" Machine Screw

Contents: 10 machine screws.

Description: Chrome plated, steel machine screws; #8-32 threads; use on general purpose applications.

**PH-17056
PH-17057**

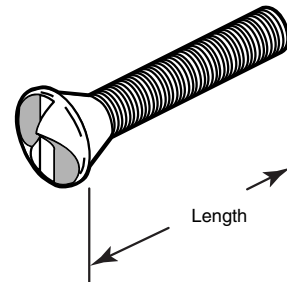

PH-17058 (No. 8 x 3/4")

PH-17059 (No. 10 x 3/4")

"One-Way" Sheet Metal Screw

Contents: 10 sheet metal screws.

Description: Chrome plated, steel metal screws; for use on various part assemblies as well as general purpose applications.

**PH-17058
PH-17059**

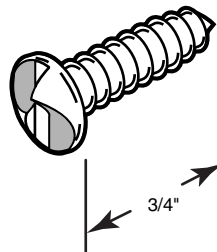

PH-17061

"One-Way" Screw Removal Tool

Contents: 1 tool.

Description: Specially designed to remove "one-way" fasteners, either #8 or #10 sizes.

You may wish to stock these related parts: **PH-17050, PH-17051, PH-17052, PH-17053, PH-17054, PH-17055, PH-17056, PH-17057, PH-17058, PH-17059, PH-17060, PH-17061.**

PH-17061

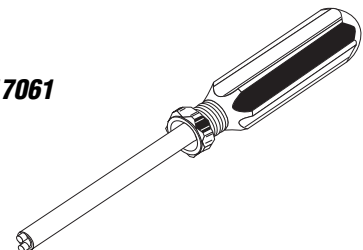

PH-17108

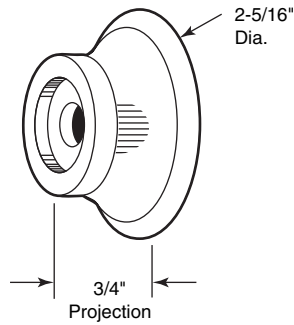

PH-17108 (Clear)

Door Bumper

Contents: 2 door stops; 2 no. 6 x 1-1/4" Phillips pan head sheet metal screws; 2 no. 6 x 1" plastic anchors.

Description: Clear soft vinyl; protects against marred walls; absorbs impact of door knob at contact point with wall; easily detached from wall by removing screw. Clear plastic construction is unassuming and allows paint colors or wall paper design to show through.

You may wish to stock these related parts: **PH-17039, PH-17040, PH-17044, PH-17061.**

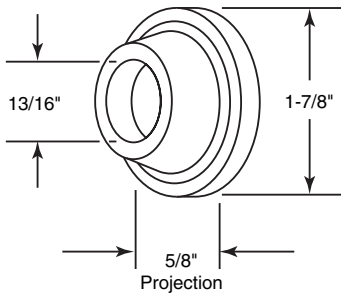

PH-17063
PH-17064

PH-17063 (White)

PH-17064 (Gray)

Door Bumper

Contents: 2 bumpers.

Description: Solid rubber; concave center; self-adhering; absorbs impact of door knob at contact point with wall.

You may wish to stock these related parts: **PH-17039, PH-17040, PH-17044, PH-17061.**

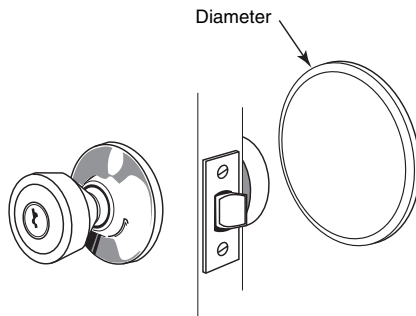

PH-17109
PH-17110

PH-17109 (3-1/4" Diameter)

PH-17110 (5" Diameter)

Wall Protector (Ivory)

Contents: 1 protector.

Description: Rigid vinyl; self adhesive; protects interior walls from impact damage by shielding contact point of wall and door knob; repairs damaged walls.

You may wish to stock these related parts: **PH-17039, PH-17040, PH-17044, PH-17061.**

PH-17107

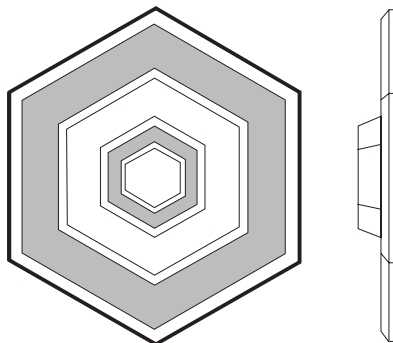

PH-17107 (White)

Wall Protector (5" hexagon)

Contents: 1 shield

Description: Flexible vinyl; self-adhesive; paintable; protects interior walls from impact damage by shielding contact point of wall and door knob; repairs damaged walls.

You may wish to stock these related parts: **PH-17039, PH-17040, PH-17044, PH-17061.**