

**GD-52100**  
**GD-52101**

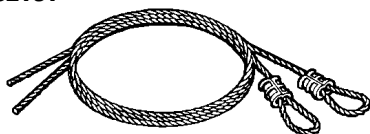

**GD-52100** (1/8" cable)  
**GD-52101** (3/32" cable)

**Extension Cables**

**Contents:** 2 - 12' cables with loop ends.

**Description:** Galvanized carbon steel aircraft cables used on extension spring doors. 1/8" replaces most wood doors, 3/32" replaces most fiberglass and aluminum doors.

**GD-52161**



**GD-52161**

**Extension Cables** (Heavy duty)

**Contents:** 2 - 14' cables with loop ends.

**Description:** 5/32" galvanized carbon steel aircraft cables used on extension spring garage doors; replaces heavy duty wood, fiberglass and aluminum door applications.

You may also wish to stock these related parts: **GD-52100**, **GD-52101**.

**GD-52102**  
**GD-52240**

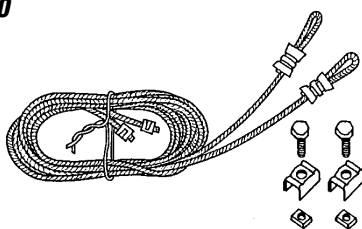

**GD-52102** (2 pack)  
**GD-52240** (4 pack)

**Safety Cables**

**Contents:** 8' 6" cables with cable clamp set.

**Description:** 1/8" galvanized carbon steel aircraft cables; installs through extension springs to prevent injury in case of breakage. Required on California installations. 4 cable set used on dual spring doors.

**GD-52183**

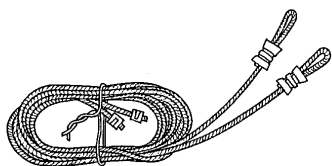

**GD-52183**

**Torsion Spring Cables**

**Contents:** 2 - 8' 8" cables with loop ends and stops.

**Description:** 1/8" galvanized carbon steel aircraft cable; for use on torsion spring doors, 7 feet high.

You may also wish to stock these related parts: **GD-52115**, **GD-52116**.

**GD-52262**

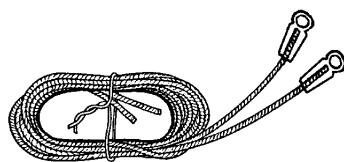

**GD-52262**

**Extension Spring Cables**

**Contents:** 2 - 13' 6" cables.

**Description:** 1/8" galvanized carbon steel aircraft cable. Special end clip designed for *Phoenix* doors.

## GD-52263

### Torsion Spring Cables

**Contents:** 2 - 8' 8" cables.

**Description:** 3/32" galvanized carbon steel aircraft cables; used on both single and double garages, fits glass doors.

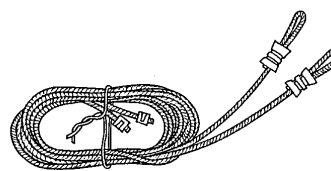

**GD-52263**

**GD-12149** (1/16")

**GD-12150** (3/32")

**GD-12151** (1/8")

**GD-12152** (5/32")

**GD-12153** (3/16")

**GD-12154** (1/4")

**GD-12256** (5/16")

**GD-12257** (3/8")

### Cable Ferrules and Stops

**Contents:** 2 ferrules; 2 stops.

**Description:** Extruded aluminum ferrules are used to clamp cable loops into fixed position; stops finish off end of cable or as a stopping point at any location on cable. Select from eight stock cable sizes.

You may wish to stock these related parts: **GD-52100**, **GD-52101**, **GD-52161**.

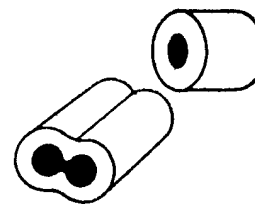

**Ferrules and Stops**

**GD-12170** (1/16")

**GD-12172** (3/32")

**GD-12174** (1/8")

**GD-12176** (5/32")

**GD-12178** (3/16")

**GD-12180** (1/4")

**GD-12258** (5/16")

**GD-12259** (3/8")

### Cable Ferrules (Bulk)

**Contents:** 100 bulk: GD-12170, GD-12172 and GD-12174  
50 bulk: GD-12176  
30 bulk: GD-12178  
20 bulk: GD-12180  
20 bulk: GD-12258  
20 bulk: GD-12259

**Description:** Extruded aluminum ferrules are used to clamp cable loops into fixed position; select from eight stock cable sizes.

You may wish to stock these related parts: **GD-52100**, **GD-52101**, **GD-52161**.



**Ferrules Only**

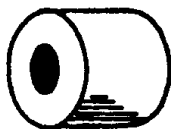

**Stops Only**

- GD-12171** (1/16")
- GD-12173** (3/32")
- GD-12175** (1/8")
- GD-12177** (5/32")
- GD-12179** (3/16")
- GD-12181** (1/4")

**Cable Stops (Bulk)**

**Contents:** 100 bulk: GD-12171, GD-12173 and GD-12175  
 50 bulk: GD-12177  
 30 bulk: GD-12179  
 20 bulk: GD-12181

**Description:** Extruded aluminum stops are used to finish off end of cable or as a stopping point at any location on cable. Select from six stock cable sizes.

You may wish to stock these related parts: **GD-52100, GD-52101.**

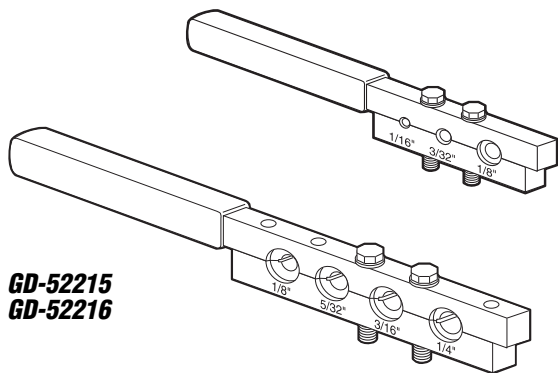

**GD-52215  
GD-52216**

- GD-52215** (1/16" - 1/8")
- GD-52216** (1/8" - 1/4")

**Swage-it Tool**

**Contents:** 1 tool.

**Description:** Heavy duty 2 piece steel swage-it tool for crimping cable ferrules to cable; not designed for crimping stops.

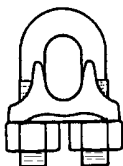

**Cable Clamps**

- GD-12251** (1/16")
- GD-12260** (3/32")
- GD-12155** (1/8")
- GD-12261** (5/32")
- GD-12156** (3/16")
- GD-12157** (1/4")
- GD-12252** (5/16")
- GD-12253** (3/8")
- GD-12254** (1/2")

**Cable Clamps**

**Contents:** 2 cable clamp assemblies.

**Description:** Steel bolts and nuts; cast aluminum base; used to clamp cable loops into fixed positions; normal loop assembly uses 3 clamps.

You may wish to stock these related parts: **GD-12149 thru GD-12154, GD-12256, GD-12257.**

- GD-12246** (1/16")
- GD-12158** (1/8")
- GD-12247** (5/32")
- GD-12159** (3/16")
- GD-12160** (1/4")
- GD-12248** (5/16")
- GD-12249** (3/8")

## Cable Thimbles

**Contents:** 2 cable thimbles.

**Description:** Carbon steel, zinc plated thimble forms non-collapsible loop in cable; protects cable strands from wear damage.

You may wish to stock these related parts: **GD-12151**, **GD-12153**, **GD-12154**.

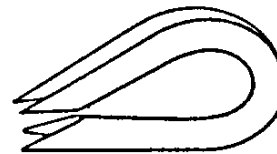

**Cable Thimbles**

- GD-52108** (4" Diameter)
- GD-52109** (3" Diameter)

## Pulley With Strap and Axle Bolt

**Contents:** 1 pulley; 1 strap; 1 axle bolt with nut.

**Description:** Heavy duty galvanized steel pulley with galvanized steel strap; case hardened steel race with steel ball bearings; factory lubricated; can be used at stationary or spring pulley positions.

**GD-52108**  
**GD-52109**

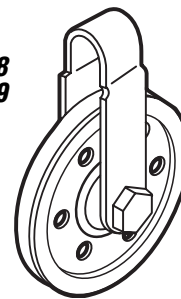

- GD-52189** (2 pack)

## Pulley With Strap and Axle Bolt (3" Diameter)

**Contents:** 2 pulleys; 2 straps; 2 axle bolts with nuts.

**Description:** Heavy duty galvanized steel pulley with galvanized steel strap; case hardened steel race with steel ball bearings; factory lubricated; can be used at stationary or spring pulley positions.

You may wish to stock this related part: **GD-52109**.

**GD-52189**

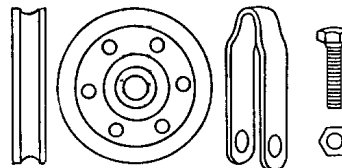

## Rollers

**Contents:** See Chart Below.

**Description:** Steel ball bearing rollers with steel inner race; factory lubricated; a selection to replace most garage door rollers.

Part No.	Dim. A	Dim. B	Dim. C	Dim. D	Pkg. Qty.	Desc.
<b>GD-52110</b>	1-7/8"	4"	7/16"	2"	2	Standard
<b>GD-52112</b>	1-5/16"	2-7/8"	5/16"	1-3/8"	2	Frantz 1"
<b>GD-52113</b>	1-7/8"	4-1/4"	5/16"	2"	2	Frantz 1/4"
<b>GD-52114</b>	1-7/8"	4-1/2"	3/8"	2"	2	Frantz 3/8"
<b>GD-52190</b>	1-7/8"	4"	7/16"	2"	4	Standard

You may wish to stock these related parts: **GD-12140**, **GD-12203**.

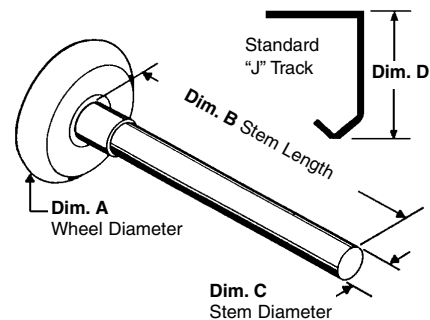

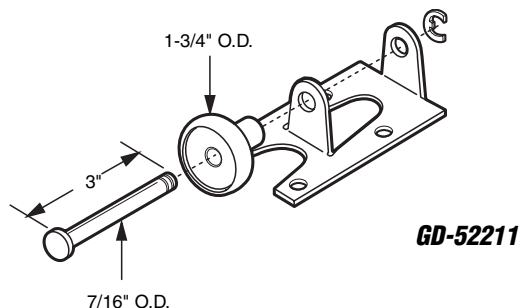
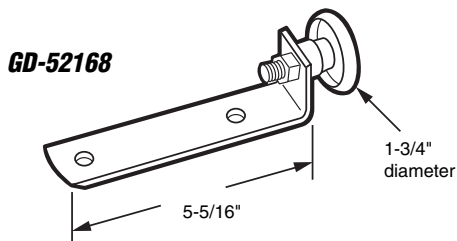
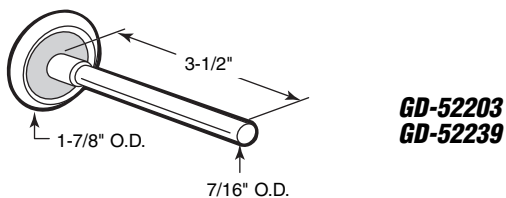
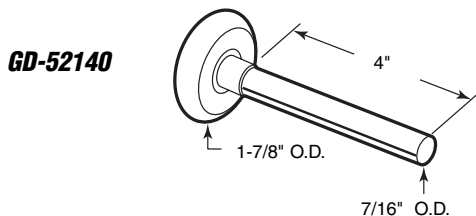
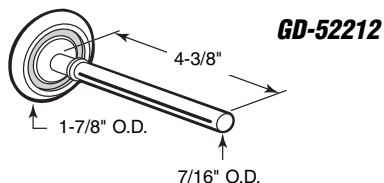
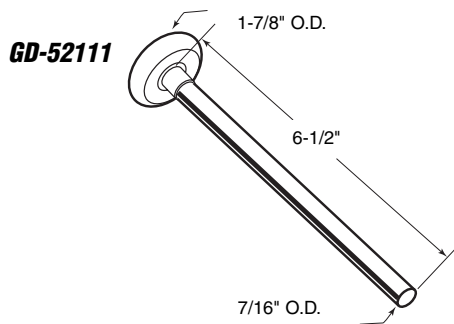

**GD-52111** (Steel ball bearing)

**Heavy Duty Roller** (Long stem)

**Contents:** 1 roller assembly.

**Description:** Heavy duty **steel roller** with **steel inner race**; **10 ball bearings**; factory lubricated; used on side by side hinge placements for added strength.

You may wish to stock these related parts: **GD-52140**, **GD-52203**.

**GD-52212** (Steel ball bearing)

**Heavy Duty Roller** (Short stem)

**Contents:** 2 roller assemblies.

**Description:** Heavy duty **steel roller** with **steel inner race**; **10 ball bearings**; same as **GD-52111** but, with shorter stem.

**GD-52140** (Nylon ball bearing)

**Standard Roller** (For 2" track)

**Contents:** 2 roller assemblies.

**Description:** **Steel ball bearing** with **steel inner race** and **nylon tire** for smooth operation; **steel shaft**; factory lubricated; excellent performance in all weather conditions.

You may wish to stock these related parts: **GD-52140**, **GD-52203**.

**GD-52203** (2 pack)

**GD-52239** (4 pack)

**Standard Roller** (Plastic)

**Contents:** Roller assemblies.

**Description:** **High impact plastic rollers** have outstanding performance characteristics in all weather environments; quiet, trouble free operation.

You may wish to stock these related parts: **GD-52110**, **GD-52140**.

**GD-52168**

**Roller and Bracket**

**Contents:** 1 roller and bracket.

**Description:** **Plastic roller** and **steel bracket**; designed for **Taylor** one-piece garage doors; requires 4 rollers per door.

*Call for Availability*

**GD-52211**

**Roller and Bracket**

**Contents:** 1 roller and bracket.

**Description:** **Plastic roller** and **steel bracket** designed for **Stanley** one-piece steel garage doors; use 4 rollers per door.

- GD-52104 (# 1 position & center)
- GD-52105 (# 2 position)
- GD-52106 (# 3 position)
- GD-52107 (# 4 position)

**14 gauge  
1 per card**

### Standard Hinge (3" overall width)

**Contents:** 1 hinge; 4 ea. 1/4"- 20 x 1-7/8" pancake head carriage bolts with nuts.

**Description:** Heavy duty 14 gauge galvanized steel hinge; roller tube accepts a standard 7/16" diameter stem roller; used by most garage door manufacturers.

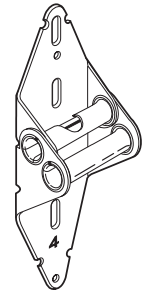

- GD-52185 (# 1 position & center)
- GD-52186 (# 2 position)
- GD-52187 (# 3 position)
- GD-52188 (# 4 position)

**14 gauge  
2 per card**

### Standard Hinge (3" overall width)

**Contents:** 2 hinges without fasteners.

**Description:** Heavy duty 14 gauge galvanized steel hinge; roller tube accepts a standard 7/16" diameter stem roller; used by most garage door manufacturers.

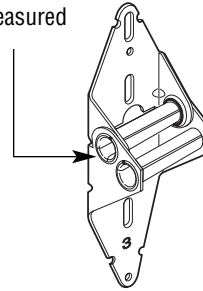

- GD-52242 (# 1 position & center)
- GD-52243 (# 2 position)
- GD-52244 (# 3 position)
- GD-52245 (# 4 position)

**18 gauge  
1 per card**

### Narrow Hinge (2-1/4" overall width)

**Contents:** 1 hinge; 4 each 1/4-20x1-7/8" pancake head carriage bolts.

**Description:** Medium duty 18 gauge galvanized steel hinge; used by many garage door manufactures; roller tube accepts a standard 7/16" diameter stem roller.

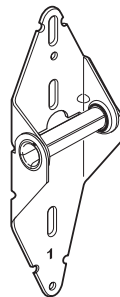
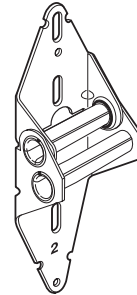

### GD-52167

#### Quick Turn Fixture

**Contents:** 1 fixture.

**Description:** Heavy duty galvanized steel; for use on low headroom garage door conditions, where automatic openers are installed.

You may also wish to stock these related parts: GD-52110, GD-52111.

**GD-52167**

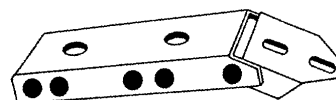

*Call for Availability*

**GD-52163**

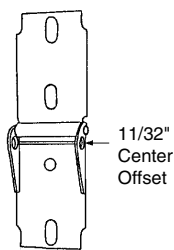

1 1/32" Center Offset

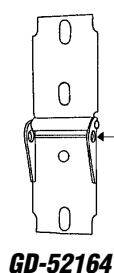

**GD-52164**

15/32" Center Offset

**GD-52165**

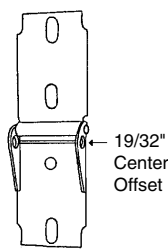

19/32" Center Offset

- GD-52163** (#1 position)
- GD-52164** (#2 position)
- GD-52165** (#3 position)

**Hinge** (For fiberglass doors)

**Contents:** 2 hinges; 8 ea. 1/4"-20 x 3/4" installation bolts.

**Description:** Heavy duty **galvanized steel**; accepts a **5/16" diameter stem roller**; fits on *Frantz* on 1200 (wood), 2400 and 2600 series doors.

You may wish to stock these related parts: **GD-52112**, **GD-52113**, **GD-52162**, **GD-52164**, **GD-52165**.

**GD-52162**

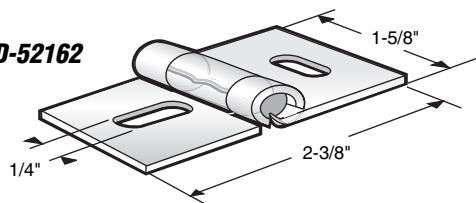

**GD-52162**

*Call for Availability*

**Center Hinge** (For fiberglass doors)

**Contents:** 2 hinges; 4 ea. 1/4"-20 x 3/4" installation bolts.

**Description:** Heavy duty **galvanized steel**; old style application; fits on *Frantz* on 1200, 2400 and 2600 series doors.

You may wish to stock these related parts: **GD-52163**, **GD-52164**, **GD-52165**.

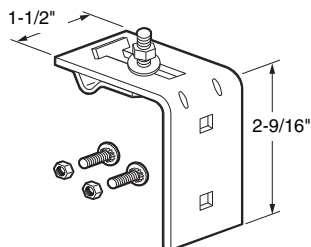

**GD-52218**

**GD-52218**

**Top Fixture Bracket**

**Contents:** 1 bracket; 2 ea. 1/4"-20 x 1/2" ribbed neck bolts and nuts.

**Description:** **Steel bracket**; adjustable; fits *Frantz* fiberglass doors.

**GD-52117**

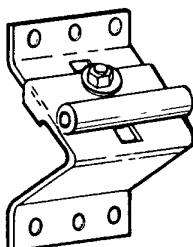

**GD-52117**

**Top Roller Fixture**

**Contents:** 1 fixture; 4 ea. 1/4" -20 x 1-7/8" pancake head carriage bolts with nuts.

**Description:** Heavy duty **galvanized steel** fixture with adjustable roller plate; accepts a standard **7/16" diameter stem roller**; used on most wood doors.

**GD-52196**

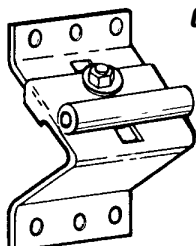

**GD-52196** (2 pack)

**Top Roller Fixtures**

**Contents:** 2 fixtures without fasteners.

**Description:** Heavy duty **galvanized steel** fixture with adjustable roller plate; accepts a standard **7/16" diameter stem roller**; used on most wood doors.

## GD-52220

### Track Brackets

**Contents:** 1 #1 & 1 #3 track bracket; 2 ea. 1/4" -20 x 1/2" ribbed neck bolts with nuts.

**Description:** Steel brackets; used to fasten track to wall.

**GD-52220**

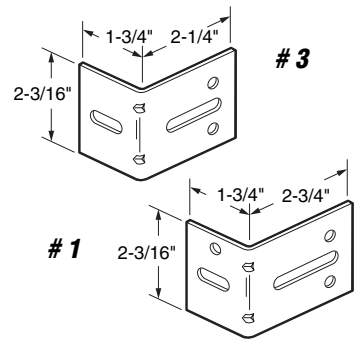

**GD-52115** (Right Hand)

**GD-52116** (Left Hand)

### Bottom Lifting Brackets

**Contents:** 1 bracket; 3 ea. 1/4"-20 x 1-7/8" pancake head carriage bolts with nuts.

**Description:** Heavy duty 13 gauge galvanized steel construction steel cable pin used on most wood doors; accepts a standard 7/16" stem diameter roller. Handling viewed from inside garage.

You may wish to stock these related parts: **GD-52100**, **GD-52101**, **GD-52115** and **GD-52116**.

**GD-52115**  
**GD-52116**

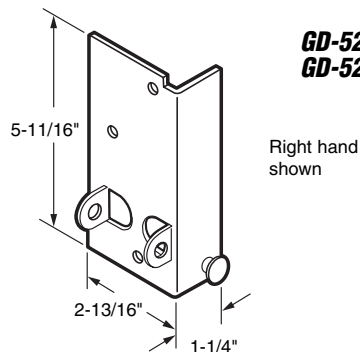

Right hand shown

**GD-52197** (2 pack)

### Bottom Lifting Brackets

**Contents:** 2 brackets (1 left hand and 1 right hand); without fasteners.

**Description:** Heavy duty 13 gauge galvanized steel construction steel cable pin; used on most wood doors; accepts a standard 7/16" diameter stem roller.

You may wish to stock these related parts: **GD-52100**, **GD-52101**, **GD-52115** and **GD-52116**.

**GD-52197**

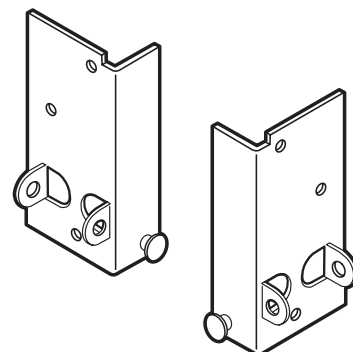

**GD-52122** (Chrome - 1 pack)

**GD-52200** (Chrome - keyed alike - 2 pack)

**GD-52213** (Brass - 1 pack)

### "T" Locking Handle

**Contents:** Locking handles with keys.

**Description:** Zinc diecast construction; keyed lock; 5/16" square shaft, 3" long; replaces most garage door, camper and R.V. locking handles.

**GD-52122**  
**GD-52200**  
**GD-52213**

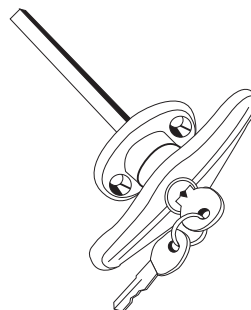

1-1/2" Hole Centers

**GD-52144** (Chrome)

### "T" Locking Handle

**Contents:** 1 locking handle; 2 keys.

**Description:** Zinc diecast construction; keyed lock; 5/16" square shaft, 2" long; replaces many garage door, camper and R.V. locking handles.

You may also wish to stock these related parts: **GD-52121**, **GD-52123**.

**GD-52144**

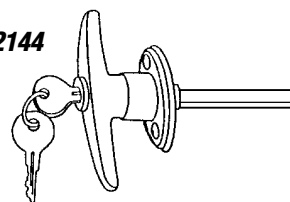

1-1/2" Hole Centers



**GD-52169**

1-1/2" Hole Centers

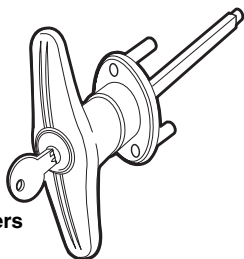

**GD-52169** (Chrome)

**"T" Locking Handle**

**Contents:** 1 locking handle; 2 keys.

**Description:** Zinc diecast construction; keyed lock; 5/16" square shaft, 3-5/8" long; replaces many garage door, camper and R.V. locking handles. Screws attach to lock from the inside of door.

**GD-52121**

**"T" Handle**

**Contents:** 1 outside handle; 1 inside handle with set screws.

**Description:** Diecast outside handle has 5/16" square, 3" long shaft; inside handle is diecast zinc with set screw; used when locking cylinder is mounted separately.

You may wish to stock this related part: **GD-52119, GD-152139, GD-52199.**

**GD-12121**

1-1/2" Hole Centers

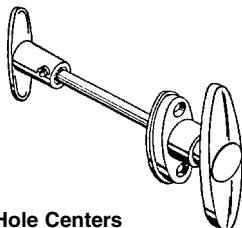

4-1/4" Hole Centers

2" Pin Centers

**GD-52147**

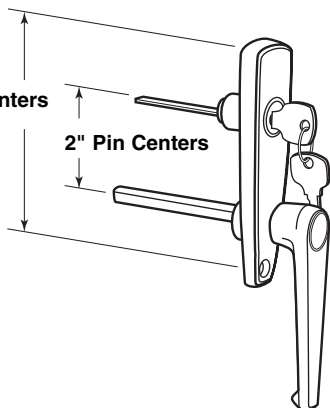

**GD-52147** (Chrome)

**"L" Handle and Locking Unit**

**Contents:** 1 handle and housing; 1 cylinder lock with 2 keys; 1 set of installation fasteners.

**Description:** Plated diecast handle and housing with 5/16" square shaft, 3-1/8" long; keyed lock with break-off spindle; works with **GD-12138** slide lock.

You may wish to stock this related part: **GD-52138.**

**GD-52123**  
**GD-52201**  
**GD-52214**

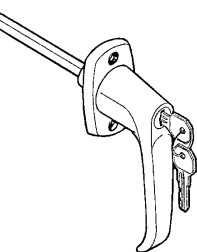

1-3/4" Hole Centers

**GD-52123** (Chrome - 1 pack)

**GD-52201** (Chrome - keyed alike - 2 pack)

**GD-52214** (Brass - 1 pack)

**"L" Locking Handle**

**Contents:** Locking handles with keys.

**Description:** Zinc diecast construction; keyed lock; 5/16" square shaft, 2-7/8" long; replaces most garage door, camper and R.V. locking handles.

**GD-52148**

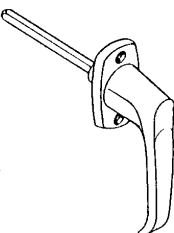

1-3/4" Hole Centers

**GD-52148** (Chrome)

**"L" Handle**

**Contents:** 1 handle.

**Description:** Diecast "L" handle with 5/16" square shaft, 3" long; non-keyed handle for use with various inside latching devices.

You may wish to stock these related parts: **GD-52119, GD-52199.**

*Call for Availability*

## GD-52138

### Side Lock

**Contents:** 1 lock assembly.

**Description:** Heavy duty **galvanized steel**, **spring loaded**, **lock** with latch bolt release lever. Used with **GD-52147** outside lock and latch assembly.

You may wish to stock these related parts: **GD-52121**, **GD-52139**, **GD-52147**.

GD-52138

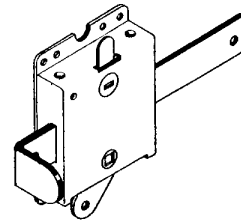

## GD-52118

### Inside Deadlock

**Contents:** 1 lock assembly; 4 ea. 1/4"-20 x 1-7/8" pancake head carriage bolts with nuts.

**Description:** 7/8" wide x 1/8" thick **steel slide bolt** with heavy duty **galvanized steel housing**; works only from the inside for extra protection as a **night or vacation security lock**; engages slot in vertical track; fits most garage doors.

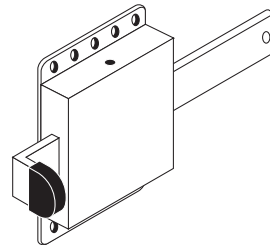

GD-52118

## GD-52137

### Slide Latch (Side Mount)

**Contents:** 1 latch.

**Description:** Heavy duty **galvanized steel** construction; spring loaded for positive latching; fits on **Frantz** and other manufacturers.

You may wish to stock these related parts: **GD-52162** thru **GD-52165**.

*Call for  
Availability*

GD-52137

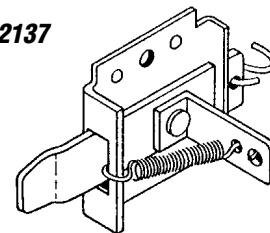

## GD-52124

### Snap Lock (Side Mount)

**Contents:** 1 latch; 1 latch strike; 3 ea. 1/4"-20 x 1-7/8" pancake head carriage bolts.

**Description:** Heavy duty **galvanized steel** construction; spring loaded for positive latching; will fit on most 2" track configurations; used by many manufacturers.

You may wish to stock these related parts: **GD-52120**, **GD-52122**.

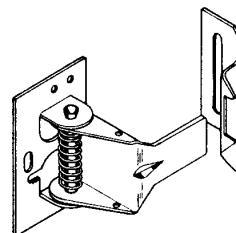

GD-52124

## GD-52219

### Strike Plate

**Contents:** 2 strikes; installation bolts.

**Description:** **Zinc plated steel** construction; used with many different style snap locks.

You may wish to stock these related parts: **GD-52120**, **GD-52122**.

GD-52219



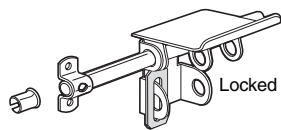
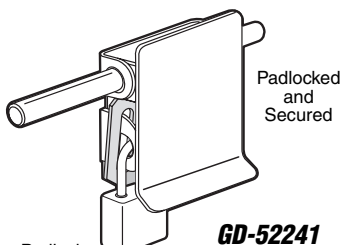
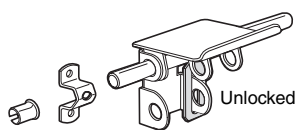

Padlock not included

**GD-52241**

**GD-52241**

**Garage & Shed Lock (Tamper-proof)**

**Contents:** 1 latch; 2 bolt keepers; installation bolts.

**Description:** Heavy gauge zinc plated steel lock; has tamperproof cover plate; can be used with surface mount or mortise bolt keepers; use with a padlock.

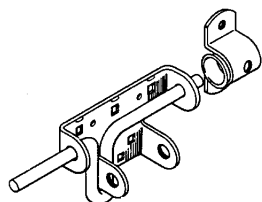

**GD-52145**

**GD-52145**

**Slide Bolt Latch**

**Contents:** 1 latch; 2 bolt keepers; 1 set of installation screws.

**Description:** Heavy gauge, zinc plated steel slide bolt latch with both surface mount or mortise bolt keepers. Use with a padlock.

**GD-52166**

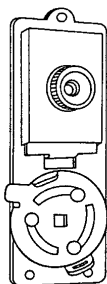

**GD-52166**

**Night Latch**

**Contents:** 1 lock assembly.

**Description:** Heavy duty galvanized steel; works with 5/16" square shaft exterior locking handle GD-52121 and GD-52139 rim cylinder; used on both *Frantz* fiberglass and wood doors.

You may also wish to stock these related parts: GD-52122, GD-52123, GD-52162, GD-52163, GD-52164, GD-52165.

*Call for Availability*

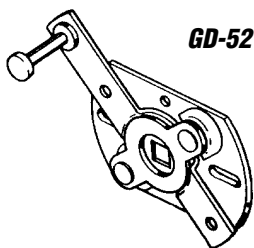

**GD-52120**

**GD-52120**

**Swivel Latch (Center Mount)**

**Contents:** 1 swivel latch; 4 ea. no. 8 x 1-1/4" Phillips pan head sheet metal screws.

**Description:** Heavy duty galvanized steel construction; accepts a 5/16" square shaft locking handle; fits on *Frantz* and others as a lever mechanism to disengage side latches.

You may wish to stock these related parts: GD-52122, GD-52123.

**GD-52119**

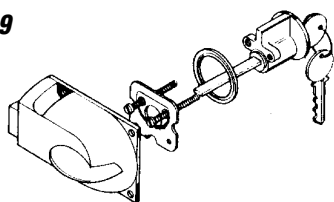

**GD-52119 (Aluminum)**

**Center Mount Deadbolt Lock**

**Contents:** 1 inside latch bolt assembly; 1 outside cylinder lock with 2 keys; 1 set of fasteners.

**Description:** Painted diecast inside lock with heavy duty steel spring bolt; key cylinder has aluminum face and 5 pin tumbler lock with cylinder ring, will replace most locking mechanisms of this type; used by many manufacturers.

You may wish to stock these related parts: GD-52139, GD-52199.

## GD-52142

### Electric Key Switch

**Contents:** 1 key cylinder with **plastic** housing and face plate assembly; 2 keys.

**Description:** Allows operation of garage door opener without a transmitter; mount to the exterior door jamb and hard wire to opener.

GD-52142

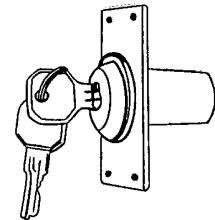

## GD-52264 (Chrome)

### Electric Key Switch (High Security)

**Contents:** 1 cylinder lock and housing assembly with 2 keys; 4 spiral nails.

**Description:** Diecast housing and waterproof cover; 7 pin cylinder lock has **chrome plated brass housing**; pick resistant, high security; momentary contact, uses 3 amp 250vac.

GD-52264

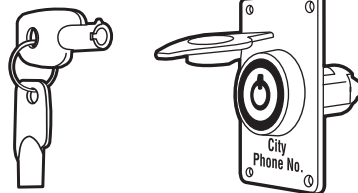

## GD-52143 (Brushed chrome)

### Emergency Release Kit

**Contents:** 1 key cylinder and housing assembly with 2 keys; 1 - 36" release cable; 1 set of fasteners.

**Description:** Diecast housing; designed to release automatic garage door opener in event of power failure; for garages without side access doors.

You may wish to stock this related part: **GD-52142**.

GD-52143

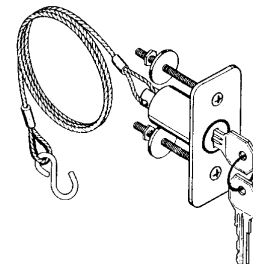

## GD-52139

### Rim Cylinder Lock

**Contents:** 1 cylinder lock with trim ring and 2 keys; 1 mounting plate and 2 screws.

**Description:** Heavy duty **zinc diecast housing** with **brass face** and **5 pin tumbler lock**. Used to key lock a variety of interior latching mechanisms.

You may wish to stock these related parts: **GD-52119**, **GD-52138**.

GD-52139

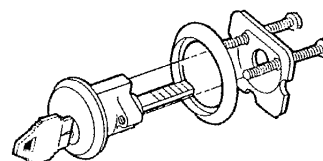

## GD-52199

### Lock Bar Disc

**Contents:** 1 disc.

**Description:** Galvanized steel disc is used to drive the door lock bars. Accepts a 5/16" square shaft handle (**GD-52121**); acts as a keeper for **GD-52119** center mount deadbolt lock.

You may wish to stock these related parts: **GD-52119**, **GD-52121**, **GD-52139**.

GD-52199

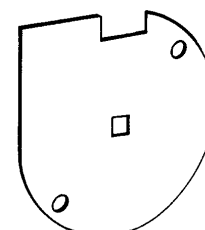

Product Number	Spring Size	Color Code	Door Size	Number of Springs on Door	Springs on each Side
<b>GD-12279</b>	<b>50 lbs.</b>	<b>Orange</b>	• Use on Single car fiberglass doors	2	1
<i>(With Safety Cable)</i>					
(25" Long)					
<b>GD-12202</b>	<b>70 lbs.</b>	<b>Yellow</b>	• Use on single car fiberglass doors	2	1
<i>(With Safety Cable)</i>					
(25" Long)					
<b>GD-12191</b>	<b>110 lbs.</b>	<b>Blue</b>	• Wood Door, 8' Wide x up to 6'6" High; 2 Panels; 4 sections • Fiberglass Door, 16' Wide x up to 7' High; 4 Sections	2	1
<i>(With Safety Cable)</i>					
(25" Long)					
<b>GD-12277</b>	<b>110 lbs.</b>	<b>Blue</b>	• Use on <b>Taylor</b> doors; for 2 car metal doors	2	1
<i>(With Safety Cable)</i>					
(29" Long)					
<b>GD-12192</b>	<b>120 lbs.</b>	<b>Green</b>	• Wood Door, 8' Wide x up to 7' High; 2 Panels; 4 Sections • Fiberglass Door, 16' Wide x 7' High; 4 Sections	2	1
<i>(With Safety Cable)</i>					
(25" Long)					
<b>GD-12193</b>	<b>130 lbs.</b>	<b>Black</b>	• Wood Door, 8' Wide x up to 7' High; 4 Panels; 4 Sections	2	1
<i>(With Safety Cable)</i>					
(25" Long)					
<b>GD-12194</b>	<b>140 lbs.</b>	<b>Red</b>	• Wood Door, 9' Wide x up to 7' High; 2 Panels; 4 Sections • Wood Door, 16' Wide x 7' High; 2 Panels; 4 Sections	2 4	1 2
<i>(With Safety Cable)</i>					
(25" Long)					
<b>GD-12195</b>	<b>150 lbs.</b>	<b>Silver</b>	• Wood Door, 9' Wide x 7' High; 4 Panels; 4 Sections • Wood Door, 16' Wide x 7' High; 4 Panels; 4 Sections	2 4	1 2
<i>(With Safety Cable)</i>					
(25" Long)					
<b>GD-12207</b>	<b>150 lbs.</b>	<b>Silver</b>	• 9' Wide x 7' High; 4 Panels; 4 Sections • 16' Wide x 7' High; 4 Panels; 4 Sections	2 4	1 2
<i>(With Safety Cable)</i>					
(22' Long - Special for <b>Frantz</b> doors)					
<b>GD-12205</b>	<b>160 lbs.</b>	<b>Brown</b>	• Wood Door, 9' Wide x 7' High; 4 Panels; 4 Sections • Wood Door, 16' Wide x 7' High; 4 Panels; 4 Sections	2 4	1 2
<i>(With Safety Cable)</i>					
(25" Long)					
<b>GD-12267</b>	<b>170 lbs.</b>	<b>Yellow</b>	• Wood Door, 10' Wide x 7' High; 4 Panels; 4 Sections • Wood Door, 16' Wide x 7' High; 8 Panel; 4 Sections	2 4	1 2
<i>(With Safety Cable)</i>					
(25" Long)					
<b>GD-12278</b>	<b>285 lbs.</b>	-	• Use on 2 car wood doors	2	1
<i>(With Safety Cable)</i>					
(28" Long)					

## Extension Springs (with Safety Cable) for Sectional Overhead Type Doors

**Contents:** 1 spring per package; **minimum order quantity 6** springs each. **Rated at 10,000 cycles.**

**Description:** Heavy duty; extension springs. It is always advisable to replace all door springs, even though only one may have broken; safety cables protect against personal injury and property damage from broken springs.

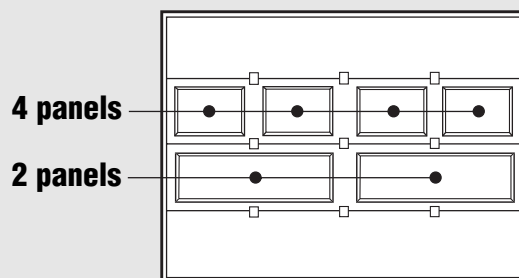
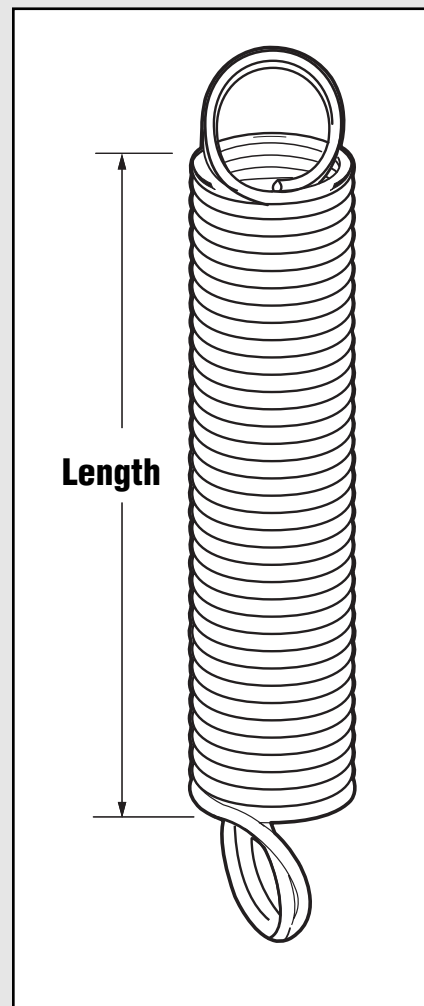

# Garage Door

**GD-52198** (2 plates for 3" pulley)

**GD-52287** (2 pairs for 4" pulley)

## Dual Spring Hook Plates

**Contents:** Hook plates.

**Description:** Galvanized steel plates used to attach 2 springs to the moving pulley strap. For heavy duty door applications.

You may wish to stock this related part: **GD-12108, GD-12109.**

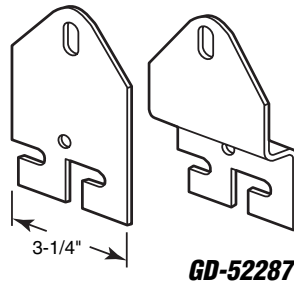

**GD-52198**

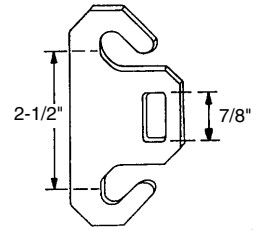

**GD-52287**

**GD-12146** - 110/120 lbs. (#728)

**GD-12255** - 135/145 lbs. (#528)

## "One Piece" Door Spring

**Contents:** 1 spring.

**Description:** Very popular West Coast spring has stamped steel end plugs attached to safety containment rods; supplied with 2 "W" hook assemblies for either one or two spring replacement. These springs are approved and certified by the State of California Department of Housing and Community Development and comply with the California Building Standards Code (CBSC) Title 24, Part 2, Section 312.7.

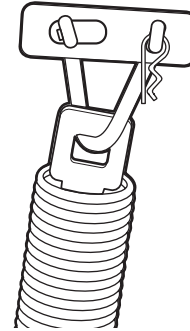

**GD-12146  
GD-12255**

**GD-12269** (16" long)

**GD-12270** (16" long - includes safety cable)

## "One Piece" Taylor Door Spring

**Contents:** 1 spring.

**Description:** Double loop spring; 1-1/4" I.D.; 10 coils = 1-7/8"; for single car garage doors. Uses a black color code.

**GD-12269  
GD-12270**

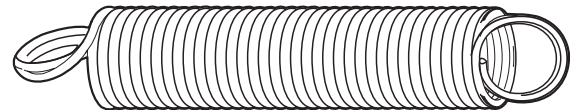

## Torsion Springs

**Contents:** 1 spring with winding cone and anchor cone attached.

Part Number	Color Code	Wire Size	Inside Diameter	Overall Length	Wind
<b>GD-12224</b>	Silver	.207	1-3/4"	18"	Right
<b>GD-12225</b>	Silver	.207	1-3/4"	18"	Left
<b>GD-12226</b>	Blue	.218	1-3/4"	20"	Right
<b>GD-12227</b>	Blue	.218	1-3/4"	20"	Left
<b>GD-12228</b>	Red	.243	1-3/4"	32"	Right
<b>GD-12229</b>	Red	.243	1-3/4"	32"	Left
<b>GD-12230</b>	White	.250	1-3/4"	32"	Right
<b>GD-12231</b>	White	.250	1-3/4"	32"	Left
<b>GD-12232</b>	Yellow	.243	2"	32"	Right
<b>GD-12233</b>	Yellow	.243	2"	32"	Left
<b>GD-12234</b>	Green	.250	2"	32"	Right
<b>GD-12235</b>	Green	.250	2"	32"	Left

**Description:** Most doors, in recent years, have been supplied with torsion springs; located directly above the door and mounted to the header. Replacement will require the use of 2 - winding rods (**GD-12238**) and a clear understanding of wire size and handing. The chart at right will help to determine these two factors.

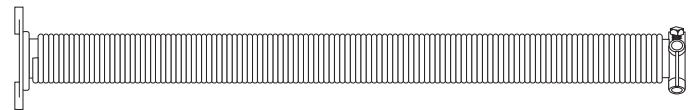

Measure 10 coils and refer to chart for wire size.

Wire Chart	Wire Size
	2-1/16" = .207
	2-3/16" = .218
	2-7/16" = .243
	2-1/2" = .250

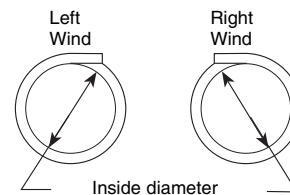
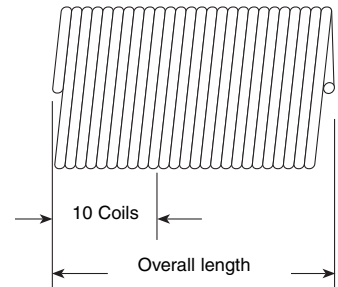

**GD-12222**  
**GD-12223**

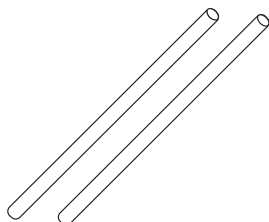
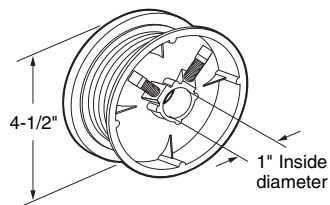

**GD-52238**

**GD-52129**  
**GD-52130**

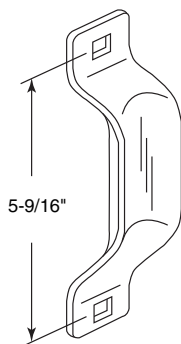
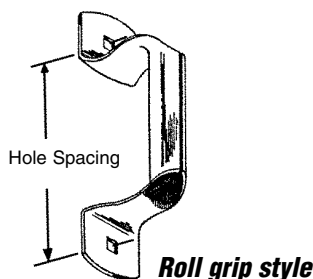

**GD-52288**  
**GD-52217**

**GD-52103**

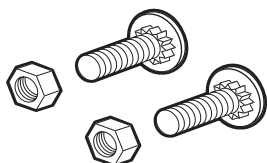
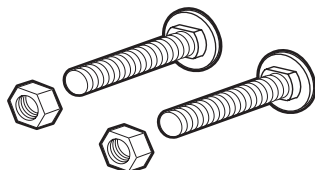

**GD-52265**

**GD-12222** (Left hand)  
**GD-12223** (Right hand)

**Torsion Spring Cable Drum**

**Contents:** 1 cable drum, with set screws.

**Description:** Diecast cable drum used on torsion spring doors; spools lifting cable as door operates. Accepts cables up to 1/8" in diameter; maximum weight load, per drum, is 265 lbs. Color coded **Red** (right hand); **Black** (left hand).

**GD-52238**

**Winding Rods**

**Contents:** 2 winding rods.

**Description:** 1/2" diameter x 16" long, hard drawn wire rods; used to wind and unwind tension on torsion springs; **these are the only tools recommended for this purpose.**

**GD-52129** (5" open grip)

**GD-52130** (6" roll grip)

**Bottom Lift Handle**

**Contents:** 2 handles; 4 ea. 1/4" -20 x 1-7/8" pancake head carriage bolts with nuts.

**Description:** Galvanized steel construction; lift handle can be used in vertical or horizontal position; replaces most handles currently in use.

**GD-52288** (Zinc plated)

**GD-52217** (Brass plated)

**Bottom Lift Handle**

**Contents:** 1 handle; 2 ea. 1/4"-20 x 1-7/8" pancake head carriage bolts with nuts.

**Description:** Steel construction; handle can be used in vertical or horizontal position; replaces most handles currently in use.

You may wish to stock this related part: **GD-12129, GD-12130.**

**GD-52103**

**Carriage Bolts With Nuts**

**Contents:** 12 ea. 1/4"-20 x 1-7/8" pancake head carriage bolts; with nuts.

**Description:** Zinc plated bolts; used to attach most hardware to garage doors; flat head allows for smooth exterior finish.

**GD-52265**

**Ribbed Neck Bolts With Nuts**

**Contents:** 12 ea. 1/4" - 20 x 1/2" pancake head, ribbed neck bolts with nuts.

**Description:** Slotted, zinc plated bolts and hex nuts; used on fiberglass garage doors.

# Garage Door

**GD-12127** (9' long)  
**GD-12128** (16' long)

*Call for  
Availability*

## Weatherstrip (Fiberglass and Aluminum Door)

**Contents:** 1 vinyl strip.

**Description:** Gray vinyl material has excellent performance characteristics in all weather conditions. Fits on fiberglass and metal doors by *Frantz, Clopay* and many other manufacturers.

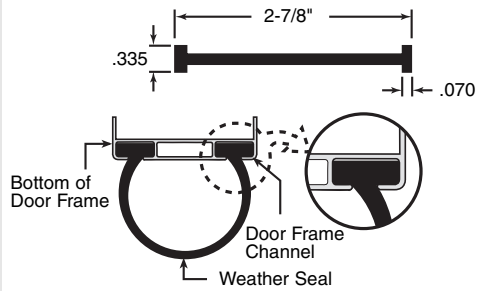

**GD-12127**  
**GD-12128**

**GD-12273** (10' long)  
**GD-12274** (16' long)

## Weatherstrip (Metal Door)

**Contents:** 1 vinyl strip.

**Description:** Fits 1 piece & metal sectional doors, weatherstrip is constructed of a gray vinyl material. Will not freeze under sub-zero temperatures.

**GD-12273**  
**GD-12274**

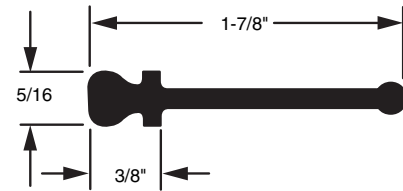

**GD-12275** (10' long)  
**GD-12276** (16' long)

## Weatherstrip (Metal Door)

**Contents:** 1 vinyl strip.

**Description:** Fits 1 piece & metal sectional doors, weatherstrip is constructed of a gray vinyl material. Will not freeze under sub-zero temperatures.

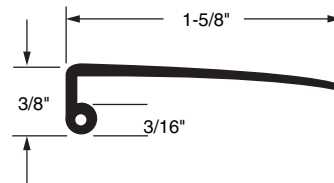

**GD-12275**  
**GD-12276**

**GD-12125** (9' long)  
**GD-12126** (16' long)

## Weatherstrip (Wood Door)

**Contents:** 1 vinyl strip with nails.

**Description:** Black vinyl material has excellent consistency even in the coldest weather; will fit a standard 1-3/8" thick garage door; used by many wood door manufacturers.

**GD-12125**  
**GD-12126**

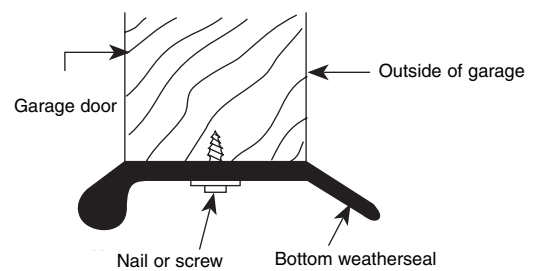

**GD-12210**

## Key Blanks

**Contents:** 25 blanks per bag.

**Description:** Standard key blanks for re-keying "T" and "L" locking handles; for **GD-12122** and **GD-12123**.

**GD-12210**

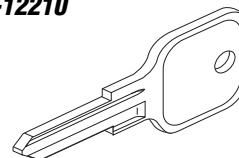



**GD-12136**

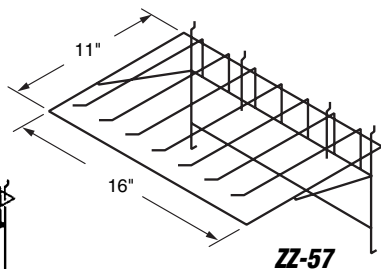
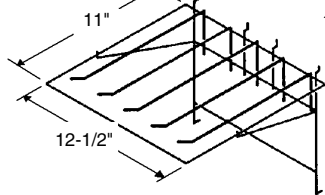

**GD-12136** (5 prong)  
**ZZ-57** (7 prong)

**Spring Rack**

**Contents:** 1 wire rack.

**Description:** Plated steel wire rack holds up to 5 or 7 different sizes of springs; attaches to existing pegboard.

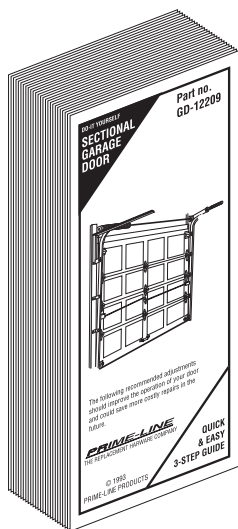

**GD-12209**

**GD-12209**  
**ZZ-34** (With wire rack)

**Maintenance Brochures**

**Contents:** 50 brochures.

**Description:** Complete how-to instructions on adjusting spring tension, leveling door, and general problem solving.

**GD-12280**

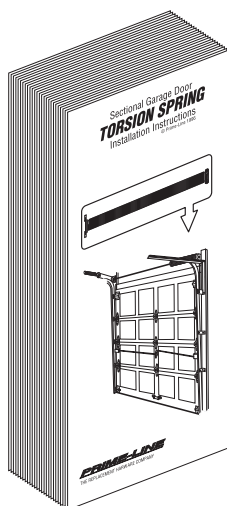

**GD-12280**  
**ZZ-58** (With wire rack)

**Torsion Spring Brochures**

**Contents:** 50 Brochures.

**Description:** Detailed instructions on how to remove and replace torsion springs. **NOTE:** It is advisable to use a professional installer for this project.

**Can't find what your looking for ?**

Call our customer service department at the number below. We may be able to source it for you!